

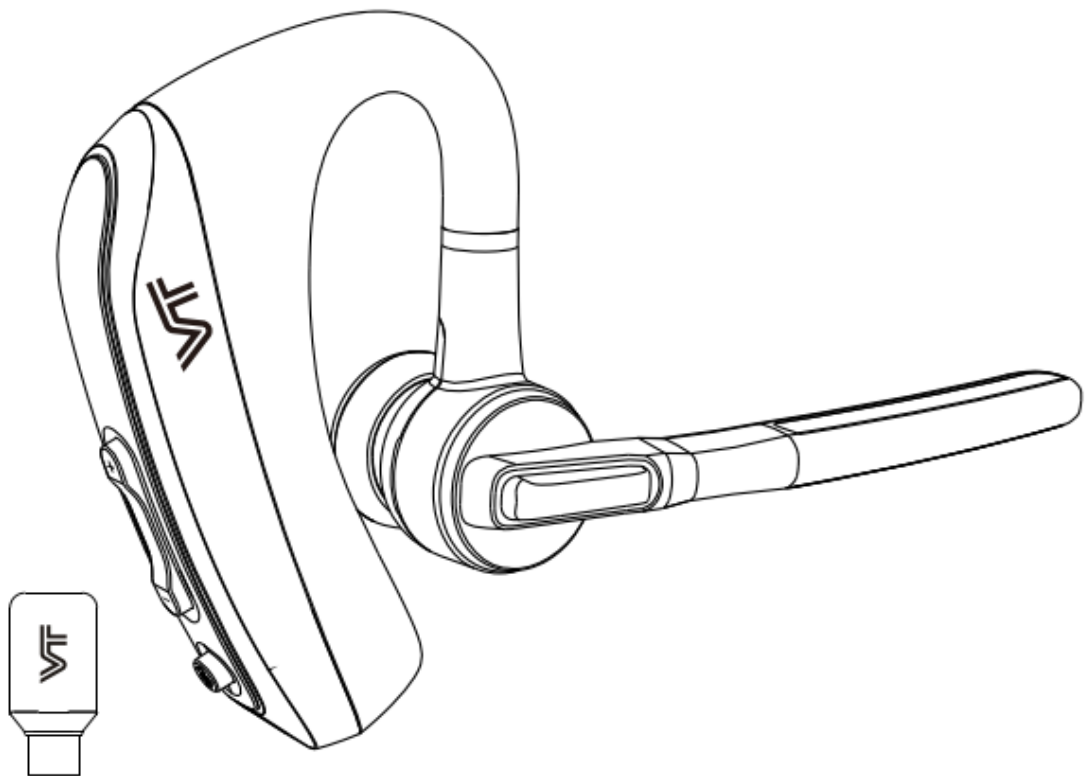

A Voice Technologist

# WIRELESS BLUETOOTH EARPIECE



**VT MH100 User Manual**

# WELCOME

Thank you for choosing VT MH100 Stereo Single Bluetooth Headset. Please read below instructions carefully before use . It will help you set up and operate this product properly and enjoy the advanced features .

## PACKING LIST



Bluetooth Headset \*1

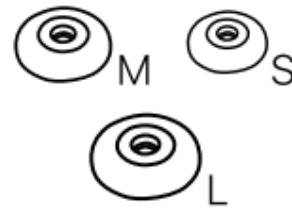

S/M/L Eartip \*1



BT 50U\*1

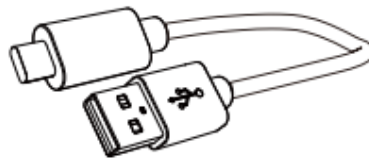

Charging Cable \*1



User Manual \*1

# DETAILED DESCRIPTION

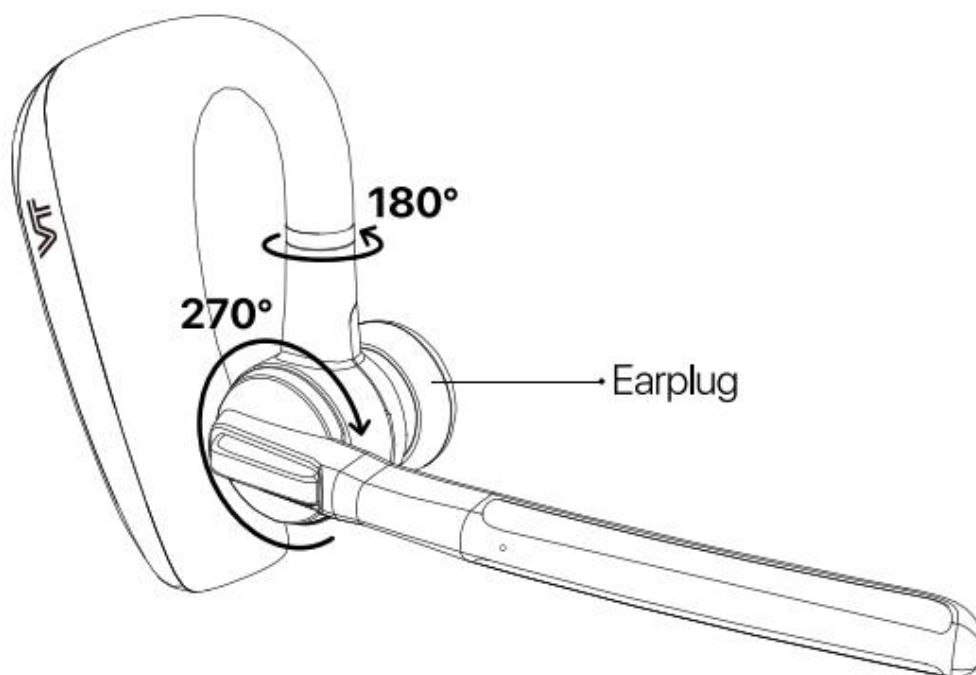
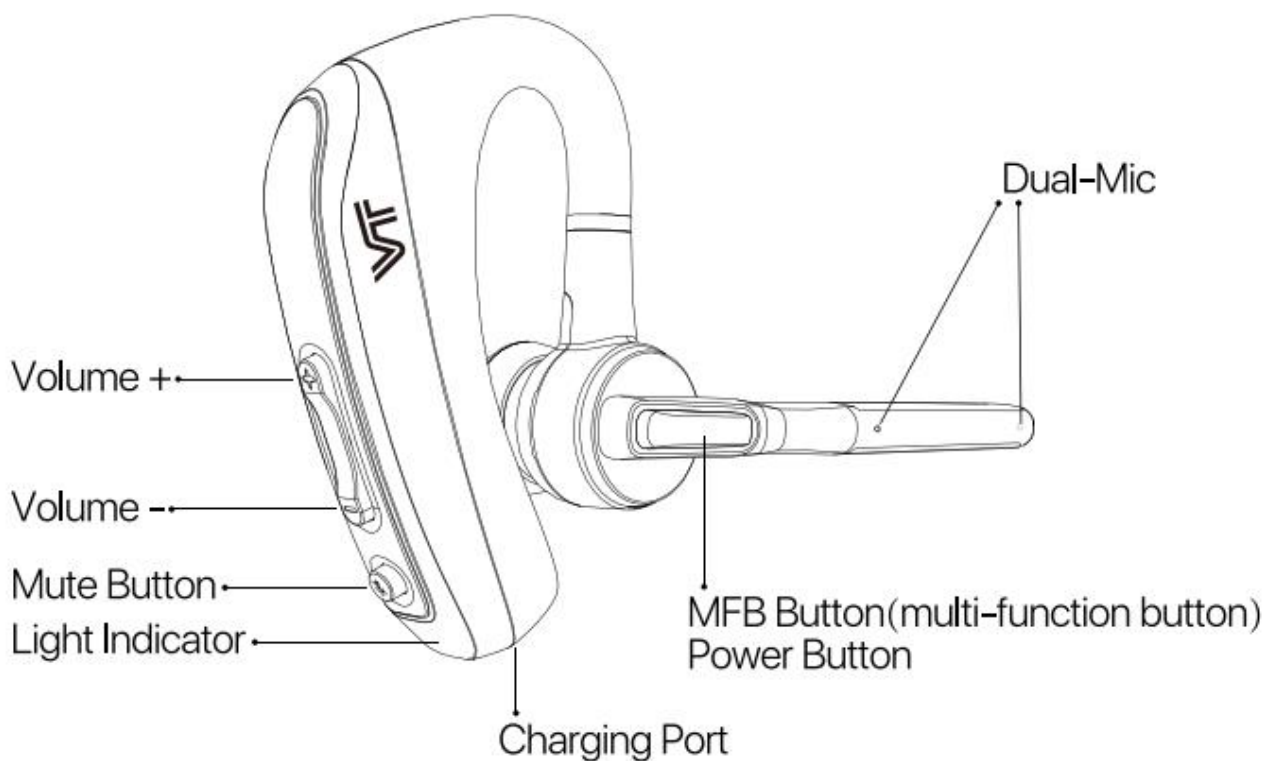

# HOW TO TURN ON THE HEADSET

- ① Take out the headset from the box,press the MFB button for 2 seconds, it will turn on and with a voice prompt"power on";
- ② And the light will flash in blue;
- ③ Continue to press the MFB button for 5 seconds to enter pairing mode, and the voice prompt will say "Pairing."
- ④ When in pairing mode, the light will flash red and blue alternately.  
(Press MFB button for 5 seconds to turn off the headset)

# HOW TO CONNECT WITH YOUR BLUETOOTH DEVICE

- ① Turn on the headset and enter the pairing function;
- ② Activate your device's bluetooth function,setting-bluetooth-activate;
- ③ Search the bluetooth item and the found our headset"VT MH100", click the"VT MH100"to connect, there will a voice prompt"Connected"

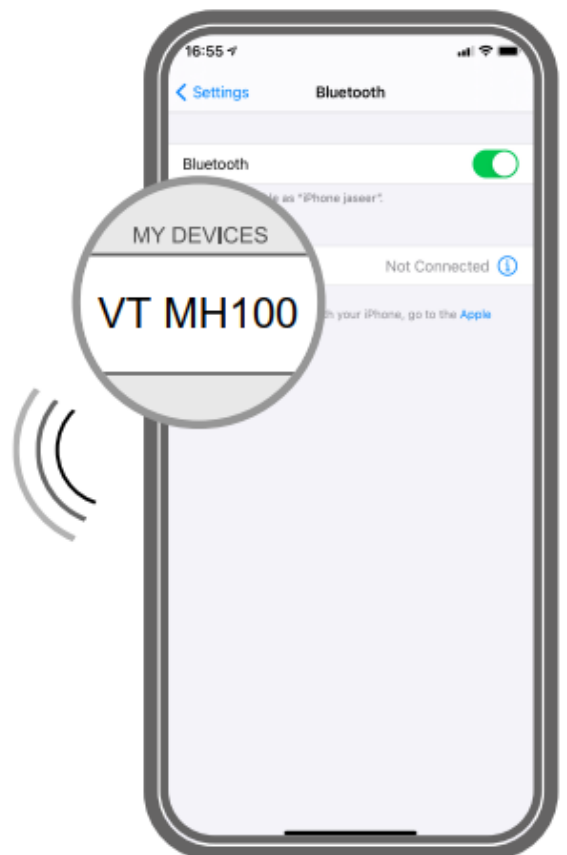
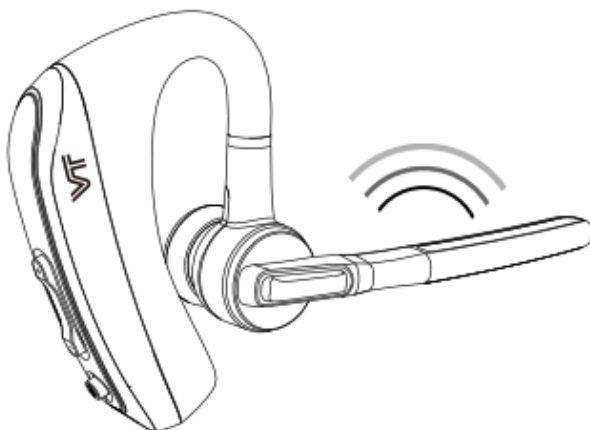

## HOW TO CONNECT TO PC (USING BT50U)

① Ensure the headset is powered on.



② Plug the BT50U into the USB port of your computer (LED light rapidly flashes blue). Place the headset and BT50U as close together as possible, wait for about 10-20 seconds, it will pair automatically. Once the LED on the BT50U stays solid blue, it indicates successful pairing.



③ If disconnected, the BT50U will automatically search for the paired device.

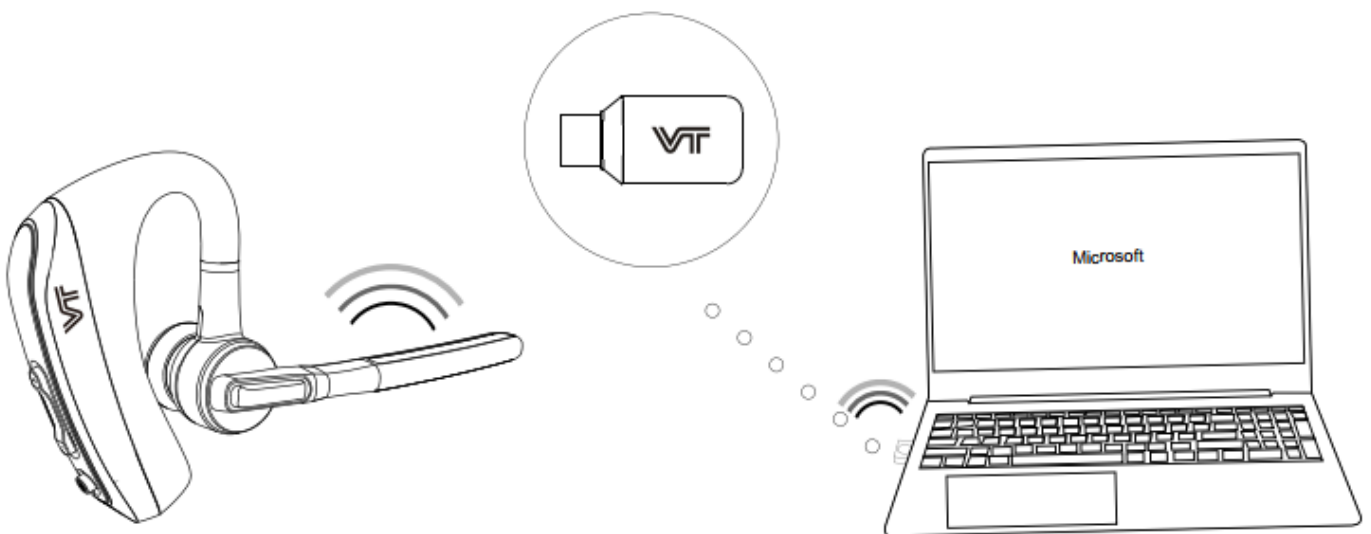

# INCOMING CALL

## Answer/end the call

Press the MFB button once

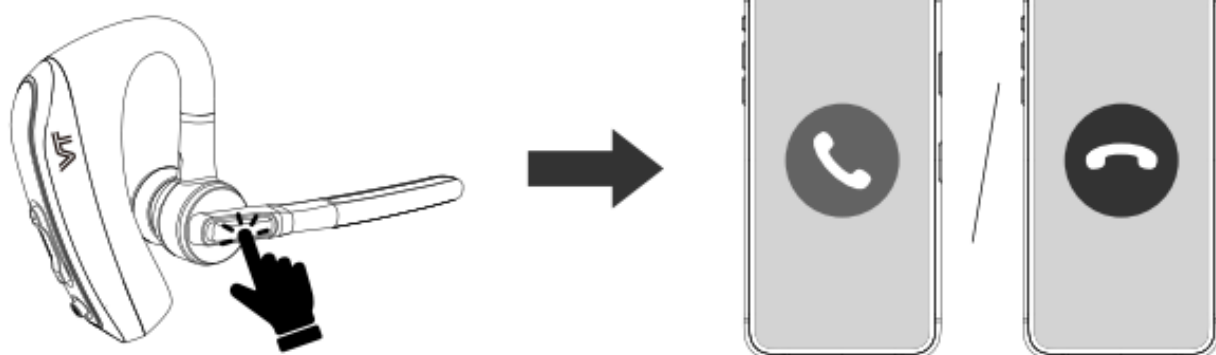

## Reject the call

Press the MFB button twice

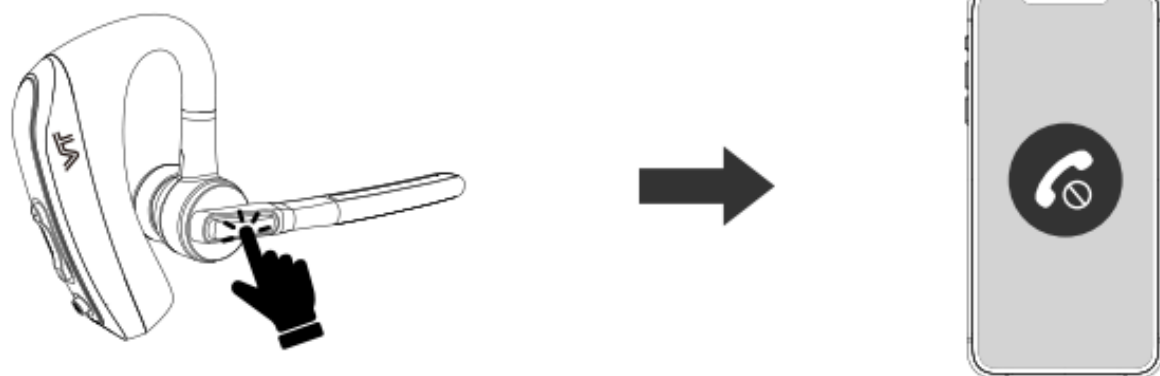

# REDIAL THE LAST CALL

Press the MFB button twice in the standby mode to redial the last call

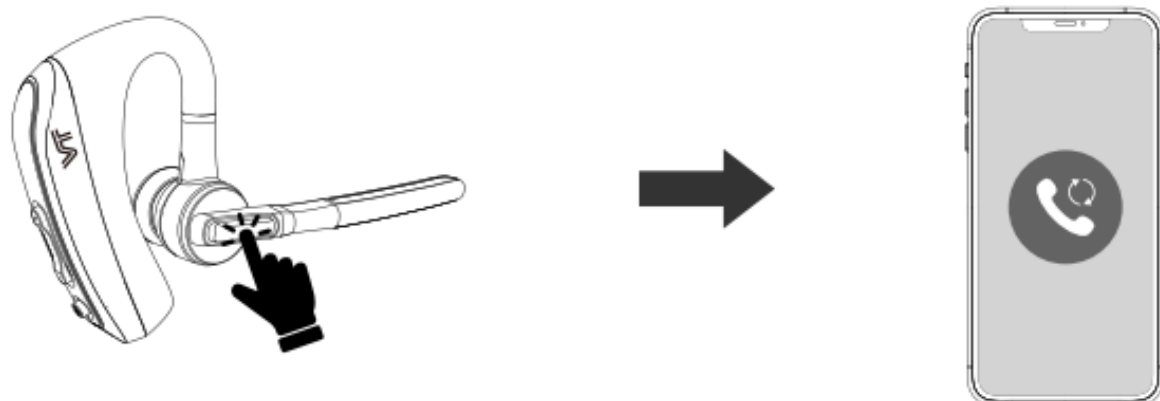

# MUSIC

## Play/Pause

In music mode, you can press the MFB button to play/pause music.

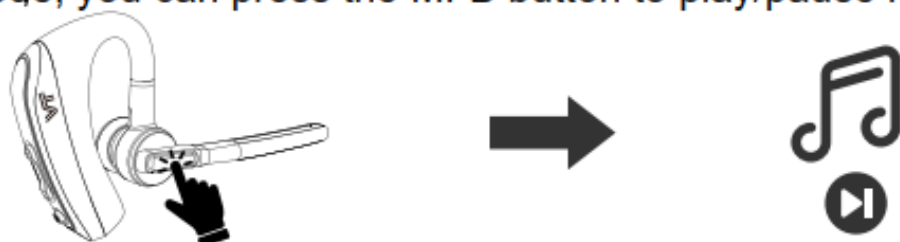

## Prevoius/Next Song

Long press the "-" button for 1.5 seconds

Long press the "+" button for 1.5 seconds

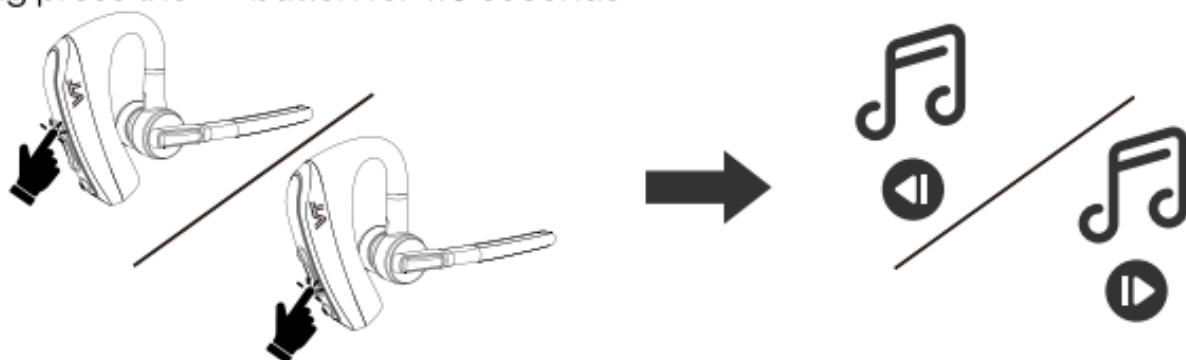

## Siri

Long press the MFB button for 2 seconds to activate siri voice assistant



## VOLUME+/-

Volume +: Press the "+" button

Volume -: Press the "-" button

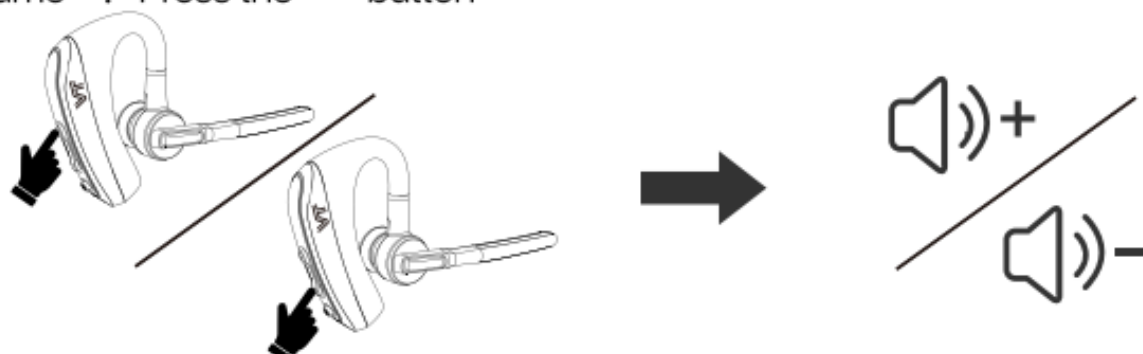

# HOW TO CHARGING THE HEADSET

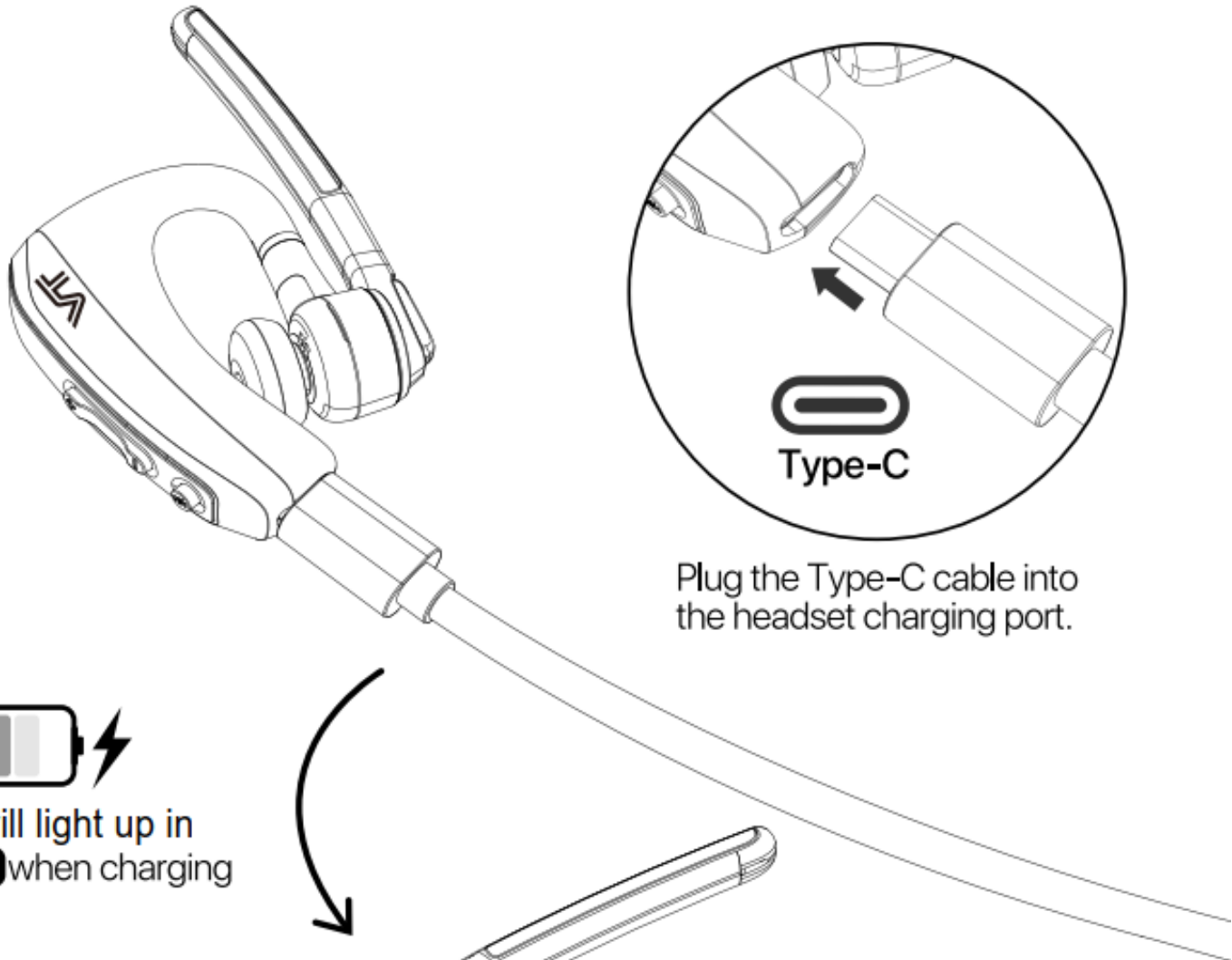

it will light up in **red** when charging

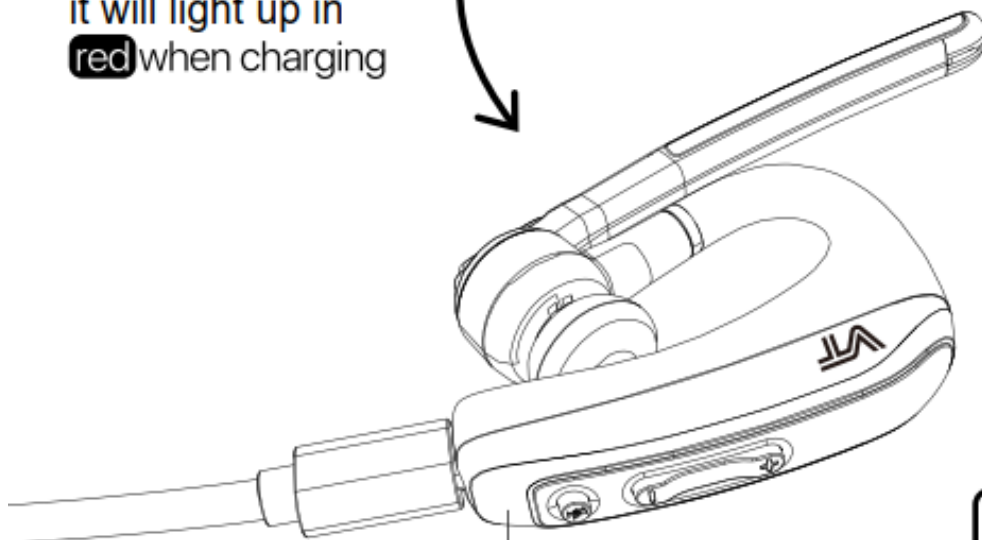

Light Indicator



and the **red** light off when fully charged



# TROUBLESHOOTING

## 1. The headset cannot be connected to the bluetooth device

### How to fix it:

- ① Confirm the status of the Bluetooth function;
- ② Turn off bluetooth function of your device, delete the historical connection and pairing again;
- ③ Or please try to connect other accessories device.

## 2. The headset can not be charged

### How to fix it:

Replace a new charging cable.

## 3. The headset does not respond

### How to fix it:

Turn off the headset and turn on it again, then try to connect with your bluetooth device.

## 4. The headset have no sound

### How to fix it:

- ① Check whether the audio track is played via the smartphone application.
- ② Check whether the headset battery is depleted.
- ③ Increase the volume of headset and mobile devices (or music playback applications).
- ④ Make sure that the correct mobile device is connected.
- ⑤ Please try to connect to other mobile devices.

# PRODUCT FEATURE

Model:	<b>VT MH100</b>
Bluetooth version:	V5.0
Working distance:	33~50 feets
Earbuds charging time:	2 Hrs
Standby time:	about 120Hrs
Charging input:	DC5.0V/1A
Capacity of headset:	150mAh
Support:	IOS/Andriod/Laptop
Functions :	Music/voice prompt/phone call
Music time :	20Hrs
Talk time :	14Hrs
Weight of single headset:	17g

**Note:** The talk and standby time may vary when using different phones or other compatible Bluetooth device, usage setting usage style and environments.

# Warning

1. Do not place device in very low or high temperature environment, in extreme temperature environment, headset may transform, battery capacity may decrease, headset lifetime may be shorten.
2. Do not use headset in storm, The headset may be broken and will increase the risk of lightening stroke.
3. Do not disassemble or refit the headset for any reason, it make broken of the headset. Please send it to sales agency to repair.
4. Repeated charging and discharging will make the battery performance reduced after sometime, this is normal for all rechargeable batteries.
5. Pls put the items and accessories to the places which can not be touched by kids or pets to avoid any unexpected accidents.

No matter the product is lost, outdated, broken or you just don't like this product, please contact our customer service, we will do our best to give you a satisfactory answer.

## VBeT Electronics Co.,Ltd

HQ Add: Unit704, Building#1, Anport International Business Center, 1696 Gangzhong Road, Huli District, Xiamen, China

Factory Add: 5th Floor Keji Building#2, No.32 Huoju East Road, Huli District Xiamen China P.C.361009

Tel : +86-592-5778728

Fax: +86-592-5778708

E-mail: vt@vbet.cn

Web: www.vbetglobal.com

